













700Qe | Series

Overlock Stitch Machine

MODEL	 x		 mm	 mm	 mm		 mm	 mm	 Needle NO. DCX27	 S.P.M. (Max)
737Qe-504M2-04	1	3	-	4	-	0.7-2	3.6	6.0	#11	7500
737Qe-504F1-04	1	3	-	4	-	0.7-2	3.6	6.0	#11	7500
737Qe-504F2-02	1	3	-	2	-	0.7-2	3.6	5.5	#9	7500
737Qe-504F1-15	1	3	-	1.5	-	0.7-2	3.6	5.5	#9	7500
737Qe-504M1-15	1	3	-	1.5	-	0.7-2	3.6	6.0	#9	7500
737Qe-505F1-04	1	3	-	4	-	0.7-2	3.6	6.0	#9	7500
737Qe-504M2-04/TR	1	3	-	4	-	0.7-2	3.6	6.0	#11	7500
737Qe-504M3-04	1	3	-	4	-	0.7-2	3.6	6.0	#11	7500
737Qe-504M3-05/PZ	1	3	-	5	-	0.7-2	3.6	6.0	#18	7500
737Qe-504M5-04/BK	1	3	-	4	-	0.7-2	3.6	6.0	#11	7500
747Qe-514M2-24	2	4	2	4	6	0.7-2	3.6	5.5	#11	7500
747Qe-512M1-25	2	4	2	5	7	0.7-2	3.6	5.5	#11	7500
747Qe-514F1-24	2	4	2	4	6	0.7-2	3.6	5.5	#11	7500
747Qe-514M2-24/TG	2	4	2	4	6	0.7-2	3.6	6.0	#11	7500
747Qe-514M2-28	2	4	2	8	10	0.7-2	3.6	4.0	#11	7500
747Qe-514H4-24/GA	2	4	2	4	6	0.7-2	3.2	5.5	#11	7500
747Qe-514M4-23	2	4	2	3	5	0.7-2	3.6	6.0	#11	7500
747Qe-514M5-23/BK	2	4	2	3	5	0.7-2	3.6	6.0	#11	7500
747Qe-514M7-24	2	4	2	4	6	0.7-2	3.6	7.0	#16	7500
747Qe-514M7-24/BK	2	4	2	4	6	0.7-2	3.6	7.0	#16	7500
747Qe-514M7-24/TG	2	4	2	4	6	0.7-2	3.6	7.0	#16	7500
757Qe-516M2-35	2	5	3	5	8	0.7-2	3.6	6.0	#14	7500
757Qe-516L1-24	2	5	2	4	6	0.7-2	3.6	6.0	#11	7500
757Qe-401M1/TW	1	2	-	-	-	0.7-2	3.6	5.5	#14	7500
757Qe-516H4-35/GA	2	5	3	5	8	0.7-2	3.6	6.0	#14	7500
757Qe-516M2-35/PS	2	5	3	5	8	0.7-2	3.6	6.0	#14	7500
757Qe-401M2-50/TA	2	4	5	-	-	0.7-2	3.6	6.0	#14	7500
767Qe-516M2-324	3	6	3+2	4	9	0.7-2	3.6	6.0	#11	7500

 高林股份有限公司
KAULIN MFG. CO., LTD.

由於對產品的改良及更新，本產品型錄中之產品規格及外觀的修改恕不事先通知！
The specification and/or appearances of the equipment described in this catalogue are subject to change without previous notice because of modification



ISO 9001:2000
ISO 14001:2004

FRANCE GENERAL MACHINES A COUDRE
13 Chemin du Génie 69200 Vénissieux
Tél : +33(0) 4 78 68 66 62 + 33(0)6 45 58 79 03
E mail : contact@fgmc.pro
<https://francegeneralmachinesacoudre.fr>



MECHATRONIC Overlock Stitch Machine

747 Qe - 514 M 2 - 2 4 / VT

线数
Thread numbers

机种别
Model

700Qe
机电一体高速型包缝机
Mechatronic High Speed
Overlock Stitch Machine

缝合方式
Sewing types

503

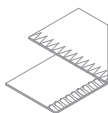

504

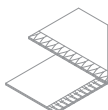

505

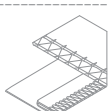

512

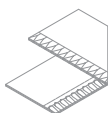

514

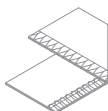

516

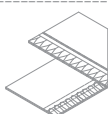

514 + 401

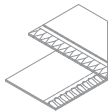

车缝布料
Sewing fabric

F: 轻薄布料
Fine weight fabric

L: 薄布料
Light weight fabric

M: 中厚布料
Medium weight fabric

H: 厚布料
Heavy weight fabric

送具型式
Feed dog type

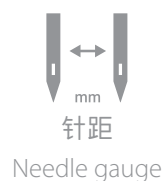

配件
Device



包边宽度
Overedge width

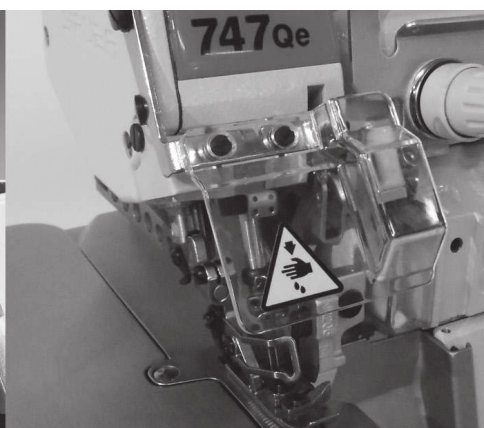
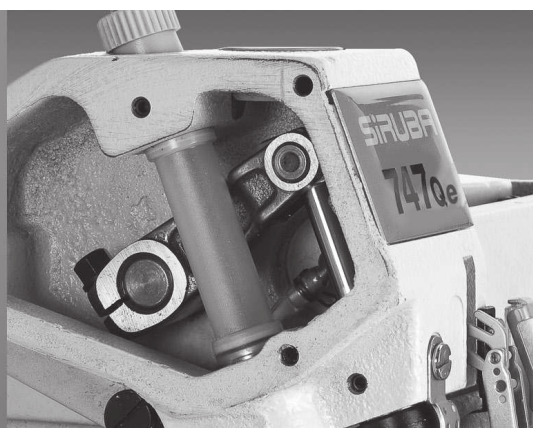



特点 / Feature

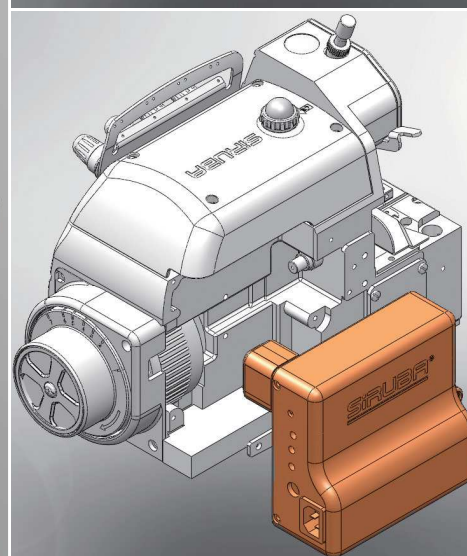
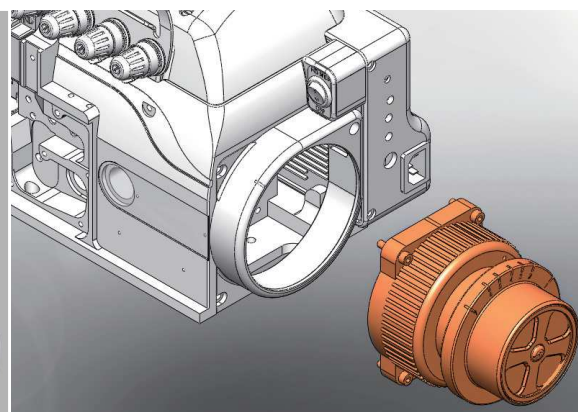

s
p
700Qe
e
d

7500 转!

机 电 一 体 再 提 升

THE UPGRADED MECHATRONICS

Qe延续Q型的精简设计，配备更强大的马达，实现7500 RPM的高速车缝。

Qe succeeds the compact design from Q Series. Equipping more powerful motor, 700Qe realizes high speed sewing by 7500 RPM.

广 泛 的 车 缝 应 用

A WIDE RANGE OF SEWING APPLICATIONS

700Qe与700K型的规格组和配件相容，提供完整的包缝工段应用。

The gauge sets and devices of 700Qe are compatible with 700K, which provides a wide range of overlock sewing applications.

ALL NEW
机电一体新纪元
MECHATRONICS

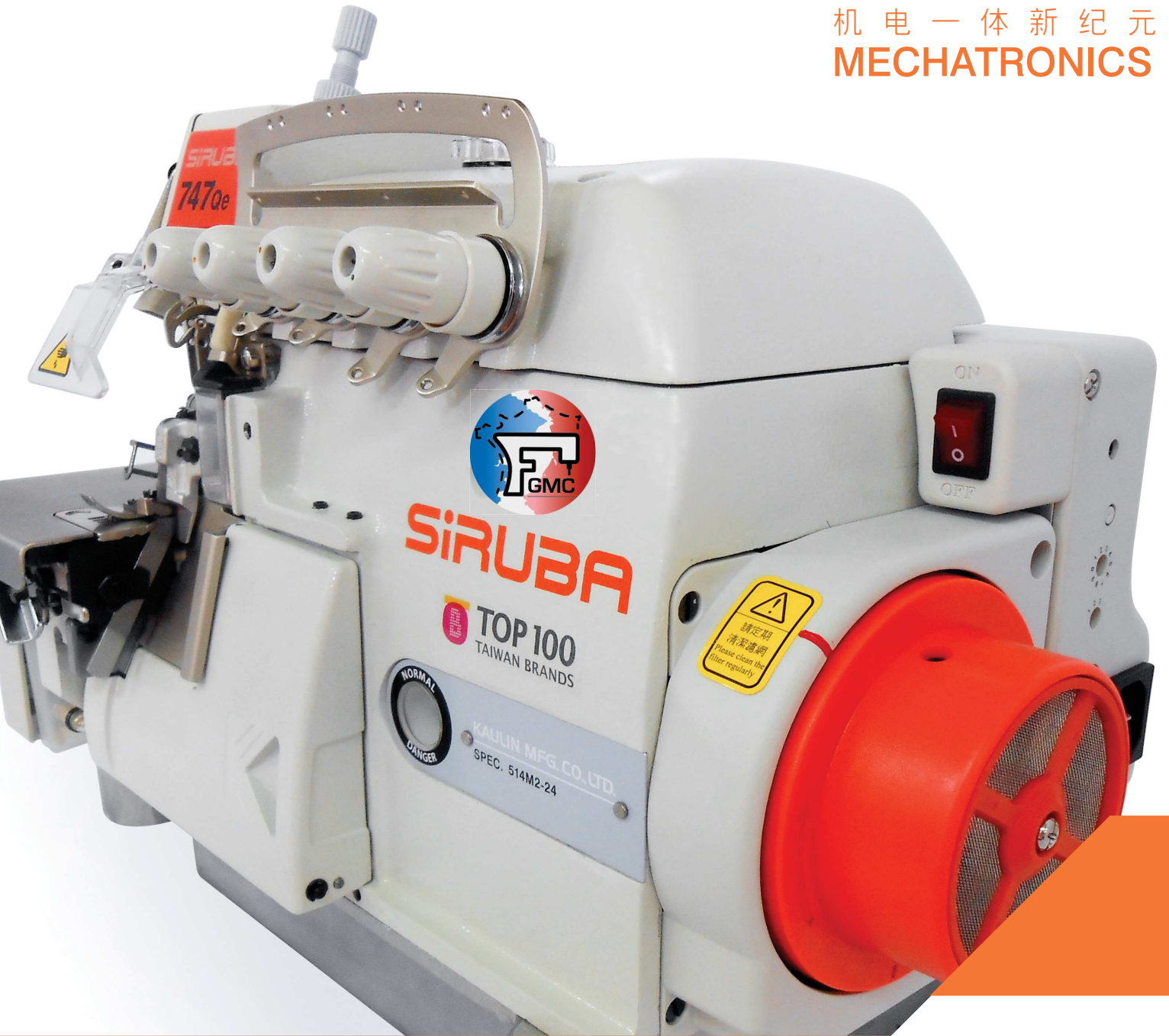

700Qe | Series

机电一体高速型包缝机
Mechatronic High Speed Overlock Stitch Machine

